

IP65 DALI-2 Multi-Sensor with ZHAGA Interface Socket

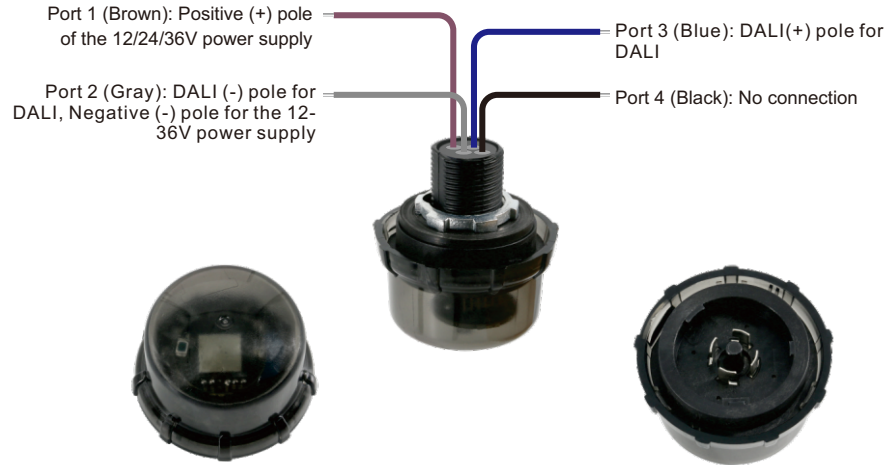

Important: Read All Instructions Prior to Installation

Function introduction



Zhaga Receptacle Structure

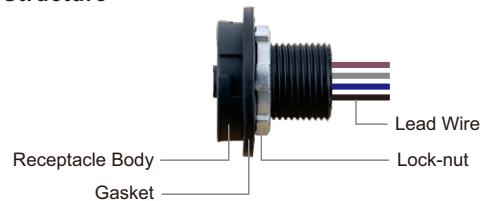

Product Description

The IP65 multi-sensor is DALI-2 and D4i certified device which combines motion sensor and light sensor. The device performs motion detection and measures illuminance level. The D4i certified multi-sensor can be easily integrated into D4i LED drivers or luminaires seamlessly, and with standard zhaga interface socket, the sensor can easily fit into various luminaires with no tools required. The sensor-equipped luminaires just need to be connected to mains power. The result is increased occupant comfort and significant energy savings that meet the most demanding building energy codes. The sensor is IP65 rating, which enables it to be used for outdoor luminaires.

The multi-sensor is D4i certified and can be powered by an AUX 24V power supply in the D4i driver or D4i luminaires, it can also be powered by an external power supply when using with non-D4i DALI drivers.

Commissioning

The multi-sensor is a DALI-2 certified device as defined in the IEC 62386 (2014) standard and can be integrated into DALI-2 systems of other vendors. It is easily configurable through a DALI-2 compliant central control unit.

The DALI-2 multi-sensor supports 2 instances standardized according to DALI: motion detector instance (303) for motion detection and light sensor instance (304) for light measurement. The multi-sensor is designed to be used in conjunction with a DALI-2 compliant central control unit. Each instance can be configured individually.

Product Data

Physical Information

Dimensions	Sensor head: D50mm*H35mm, Receptacle: D30mm
Mounting	M 20X1.5 thread
Thread length	18.5 mm
Receptacle	D30mm
Gasket Dimensions	D36.5mm
Wires	AWM1015, 20AWG, 6"(120 mm)

Electrical Information

Power Supply	12/24/36 VDC (D4i Certified)
Typical DALI Current Draw	2mA
Control	DALI
Marking Terminals	V+, GND (DALI-), DA+
Status Indicators	Red (DALI status), Red (motion detection)

Sensing

Motion Detection (62386 - 303)	Microwave sensor
Microwave High Frequency	5.8 GHz ±75 MHz ISM band
Detection Sensitivity	0-15 Configurable, 0 is the highest sensitivity
Light Sensor (62386 - 304)	Event: 0-1000 Lux (10bit), resolution: 10lux
Mounting Height	Up to 49ft (15m), recommended height: 13-26ft (4-8m)
Detection Angle	150° (wall), 360° (ceiling)
Function	Configurable

Environment

Operating Temperature Range	-40°F to 104°F / -40°C to 70°C
Operating Humidity	0-95% (non condensing)
Safety Certification	cULus Listed, CE

Key Features

- DALI-2 & D4i certified
- Microwave motion detection
- Motion sensor instance type 3 (303)
- Illuminance measurement
- Light sensor instance type 4 (304)
- Autonomous sensor-based control
- Seamlessly working with D4i drivers
- Zhaga book 18 socket
- Plug & Play
- IP65 rating, can be used for outdoor luminaires

Applications

- Warehouses
- Factories
- Street and Area Lighting
- Outdoor Luminaires - Wall Packs - Parking Lots - Walkways
- Photo Controls
- Central Management System

Benefits

- Easily fit into various luminaires with standard zhaga interface socket
- Cost-effective solution for energy savings
- Energy code compliance
- Compatible with universal DALI-2 compliant central control unit that supports sensor input devices

Safety & Warnings

- DO NOT install with power applied to device.

Application & Function

Instances

The DALI-2 multi-sensor supports 2 instances standardized according to DALI: occupancy sensor instance (303) for motion detection and light sensor instance (304) for light measurement.

- Instance number 0: instance type is Occupancy sensor
- Instance number 1: instance type is Light sensor

Instances-General

Each instance can be configured individually. Some settings have the same functionality for all sensor instances and are therefore described in this section. Instance specific settings are explained for each individual instances in the following respective sections.

Enable/Disable

If instances are not required, they can be deactivated. In this case, event messages are not sent, and the measured values are not updated. They can, however, still be queried via a "Query" command, and the DALI-2 configuration commands and queries are still supported.

Event Scheme

The event scheme determines which information is transferred with the event. This information is required, to enable recognition and / filtering of events on the bus. The following 5 options are available:

- **Instance addressing:** instance type and instance number
- **Device Addressing:** device address and instance type
- **Device/Instance Addressing:** device address and instance number
- **Device Group Addressing:** device group and instance type
- **Instance Group Addressing:** instance group and instance type

Instance group: up to three instance groups can be assigned for each instance. Only the "Primary Group" is used for the event.

Instance type: the instance type defines which DALI-2 standard is valid for this instance. (The different instance types are specified in the DALI-2 standard.)

Instance number: each instance in a device has a unique instance number.

Device group: The device can be assigned to up to 32 device groups (0..31). The lowest device group is used for the event.

Device address: a device address (or short address) (0..63) can be assigned to each device. With this the device can be clearly addressed. (Identical short addresses should be avoided.)

Event Priority

The event priority determines the order in which events are sent when they occur simultaneously on the bus. Priority 2 = highest and 5 = lowest.

Dead Time

The dead time can be set for each instance. It determines the time that must pass before an event can be sent again. This also applies if the event information (measured value) changes. If no dead time is required, it can be deactivated.

Report Time

If the event information does not change, the event is sent cyclically with the report time. The report time can be set for each instance. It determines the maximum time between a sent event and re-sending.

Hysteresis

Not every change in value leads to an event being generated. The hysteresis can be used to set which percentage change is necessary to trigger a new transmission. Attention, the hysteresis band is not arranged symmetrically. The following applies:

Increasing value

The condition for an event is only fulfilled if the next value falls below the previous value minus the hysteresis or if the next value is greater than the previous value.

Decreasing value

the condition for an event is only fulfilled if the next value exceeds the previous value plus the hysteresis or the next value is smaller than the previous value.

Hysteresis Min

Hysteresis Min is the minimal hysteresis value that cannot be fallen below of.

Instance 0 – Motion

Instance 0 is an instance standardized by DALI-2 (62386-303), for sensors that detect motion. All settings are implemented according to the standard. The instance is DALI-2 certified.

The sensor switches between the following states:

- People in the room and movement (0xFF)
- People in the room and no movement (0xAA)
- Empty room (0x00)

If the sensor detects movement, it immediately changes to the state: "people in the room and movement". This state is exited after 1 second at the earliest if no further movement is detected. In this case it changes to the state "People in the room and no movement". After the hold time has expired it changes to the state "Empty room"- Vacant.

Hold Time: hold time is the time that must pass before the state "people in the room and no movement" is changed to the state "empty room". If movement is detected during this time the state is changed back to: "People in the room and movement". (min. 1 second)

Query Input Value: The current sensor state can be queried using this DALI command. The following values are possible: 0x00, 0xAA, 0xFF (see paragraph above for the possible states)

Event: the sensor status is transmitted by events. The following event information is available:

Event name	Event Information	Description
No movement	00 0000 ---0b	No movement detected. Corresponding trigger is the 'No movement' trigger.
Movement	00 0000 ---1b	Movement detected. Corresponding trigger is the 'Movement' trigger.
Vacant	00 0000 -00-b	The area has become vacant. Corresponding trigger is the 'Vacant' trigger.
Still vacant	00 0000 -10-b	The area is still vacant. The event occurs at regular intervals as long as the vacant condition holds. Corresponding trigger is the 'Repeat' trigger.
Occupied	00 0000 -01-b	The area has become occupied. Corresponding trigger is the 'Occupied' trigger.
Still occupied	00 0000 -11-b	The area is still occupied. The event occurs at regular intervals as long as the occupied condition holds. Corresponding trigger is the 'Repeat' trigger.
Movement sensor	00 0000 1---b	The current event is triggered by a movement based sensor.
	1x xxxx xxxxb	Reserved.
	01 xxxx xxxxb	
	00 1xxx xxxxb	
	00 01xx xxxxb	
	00 001x xxxxb	
	00 0001 xxxxb	

For more details please refer to the standard IEC62386-303.

Event filter: The event filter defines for which status change an event is generated.

Filter arrangement:
 Bit0: Occupied Event active
 Bit1: Vacant Event active

Bit2: Still Vacant/Occupied Event active
 Bit3: Movement Event active
 Bit4: No Movement Event active
 Bit5..Bit7: unused

Report Time: report time can only be set if the event filter "Repeat" is activated and the events: "Still Vacant" and "Still Occupied" are enabled. The time between sending a "Still-Event" again is determined by the Report Time.

Configuring Instance 0 – Occupancy Sensor

1. Set filter (SET EVENT FILTER): 1 Byte, corresponding relationship of each BIT and default value are as follows:

Bit	Description	Value	Default
0	Occupied event enabled?	"1" = "Yes"	1
1	Vacant event enabled?	"1" = "Yes"	1
2	Repeat event enabled?	"1" = "Yes"	0
3	Movement event enabled?	"1" = "Yes"	0
4	No movement event enabled?	"1" = "Yes"	0
5	Reserved	0	0
6	Reserved	0	0
7	Reserved	0	0

This command value: 0x68

2. Set hold time (SET HOLD TIMER (DTR0))
 1 Byte, (1---255), actual value: HOLD TIMER×10S
 This command value: 0x21

3. Set report time (SET REPORT TIMER (DTR0))
 1 Byte, (0---255), actual value: REPORT TIMER×1S
 This command value: 0x22

4. Set dead time (SET DEADTIME TIMER (DTR0))
 1 Byte, (0---255), actual value: DEADTIME TIMER×50MS
 This command value: 0x23

5. Set sensor sensitivity (SET sensitivity (DTR0))
 1 Byte, (0---100), valid value range is 0---15, 0 is the highest sensitivity, 15 is the lowest sensitivity
 This command value: 0x26

6. Query sensor sensitivity (SET sensitivity (DTR0))
 1 Byte, (0---100),
 This command value: 0x2b

7. Query instance resolution (QUERY RESOLUTION)
 The resolution of occupancy sensor input value is 2,
 This command value: 0X81

8. Query current input value of instance (QUERY INPUT VALUE)
 Input values of occupancy sensor (4 values: 0, 0x55, 0xaa, 0xff),
 This command value: 0x8c

Instance 1 – Light intensity

Instance 1 is an instance standardized by DALI-2 (62386-304). All settings are implemented according to the standard. The instance is DALI-2 certified.

The current light value (lux) is measured by the sensor and can either be queried using a "Query" command or can be automatically provided by the sensor using an event.

The measuring range is 0Lux ... 1000Lux. The resolution differs between queries and generated events. A query supports an event resolution of 10Lux (10Bit).

Hysteresis: For information on the hysteresis see section Instances -General: Hysteresis

Hysteresis Min: set in lux. For general information on the hysteresis min see section Instances – General: Hysteresis Min

Event Filter: The light instance generates only one event with 10-bit resolution (0... 1000 lux, step size 10lux). If the filter is deactivated, no events will be sent.

Event: the illuminance level is transmitted by event. The following event information is available:

Event name	Event Information	Description
illuminance level report	illuminanceEvent	An illuminance level report, passing the actual illuminance level along.

For more details please refer to the standard IEC62386-304.

Configuring Instance 1 – Light Sensor

1. Set filter (SET EVENT FILTER): 1 Byte, only 1 BIT used, corresponding relationship and default value are as follows:

Bit	Description	Value	Default
0	Illuminance level event enabled?	"1" = "Yes"	1
1	Reserved	0	0
2	Reserved	0	0
3	Reserved	0	0
4	Reserved	0	0
5	Reserved	0	0
6	Reserved	0	0
7	Reserved	0	0

This command value: 0x68

2. Set report time (SET REPORT TIMER (DTR0))
 1 Byte, (0---255), actual value: REPORT TIMER×1S
 This command value: 0x30

3. Set dead time (SET DEADTIME TIMER (DTR0))
 1 Byte, (0---255), actual value: DEADTIME TIMER×50MS
 This command value: 0x32

4. Set hysteresis (SET HYSTERESIS (DTR0))
 1 Byte, (0---25%), actual value: HYSTERESIS ×current illuminance value
 This command value: 0x31

5. Set hysteresis min (SET HYSTERESIS MIN (DTR0))
 1 Byte, (0---255)
 This command value: 0x33

6. Query instance resolution (QUERY RESOLUTION)
 The resolution of illuminance is 10,
 This command value: 0x81

7. Query instance current value (QUERY INPUT VALUE)
 Current value of illuminance (0-1000),
 This command value: 0x8c

8. Query instance current latch value (QUERY INPUT VALUE LATCH)
 This command value: 0X8d

Detection Area

Note:

- 1) Following different detection areas are based on different installation heights & patterns.
- 2) For all detection areas, the sensitivity is set to 0 the highest.
- 3) For all detection areas, the movement speed is 0.2-0.3m/S.

Ceiling Pattern (Unit: m)
Installation Height: 2.5m

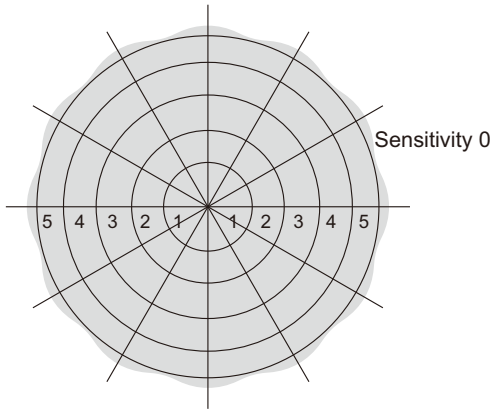

Wall Pattern (Unit: m)
Installation Height: 2.5m

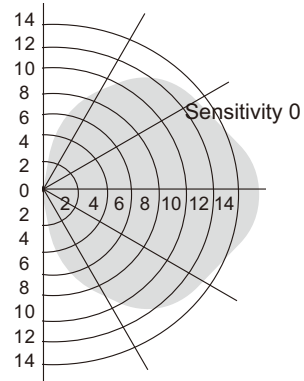

Ceiling Pattern (Unit: m)
Installation Height: 5m

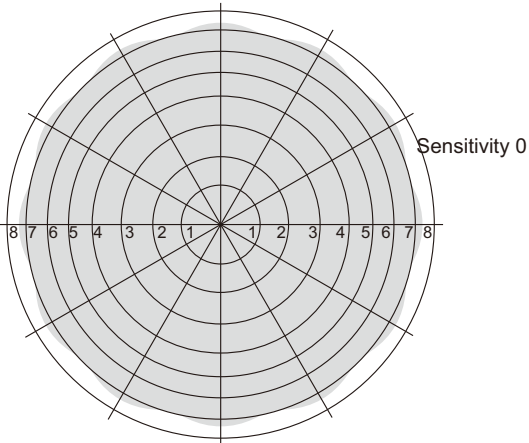

Wall Pattern (Unit: m)
Installation Height: 5m

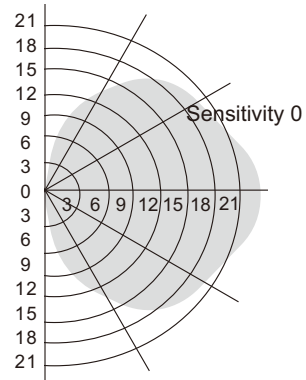

Ceiling Pattern (Unit: m)
Installation Height: 10m

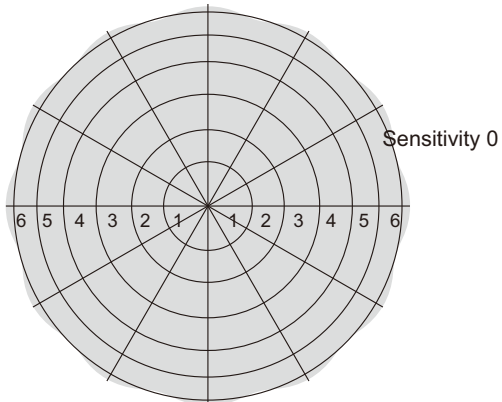

Wall Pattern (Unit: m)
Installation Height: 10m

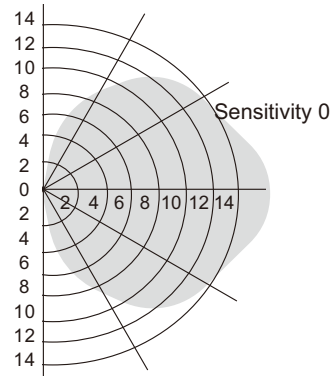

Wiring Diagram
1) With Non-D4i DALI Drivers

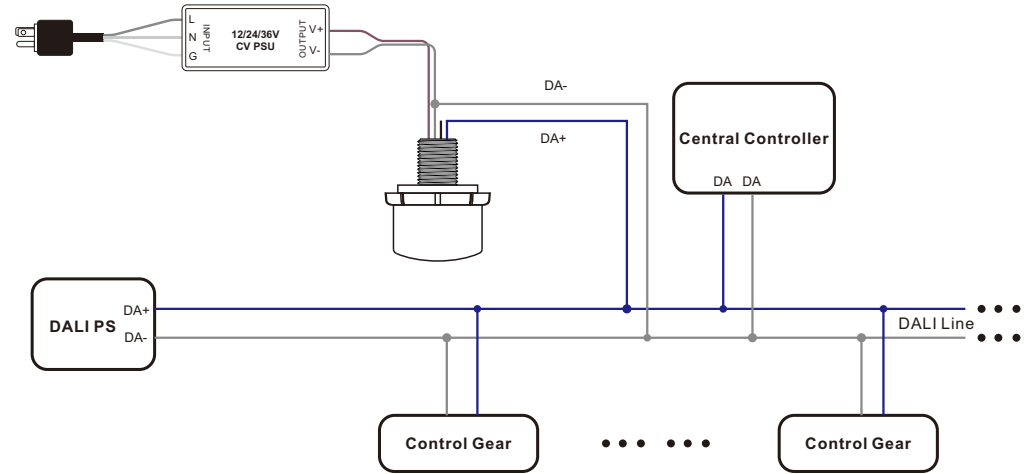

Note: please make sure the polarity of DALI of the sensor is correctly wired to the DALI PS.

2) With D4i Drivers that Provide DALI PS & AUX 24V Power Supply

Note: please make sure the polarity of DALI of the sensor is correctly wired to the DALI PS.

